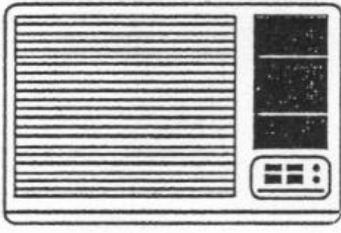




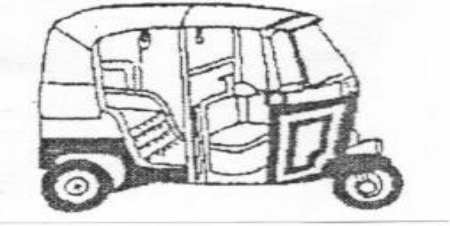


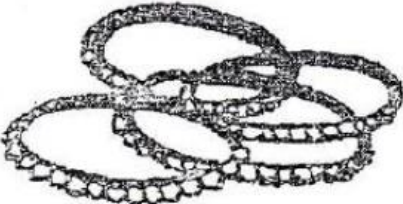


सारणी - IV

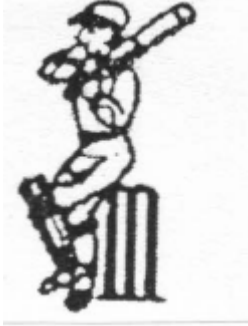
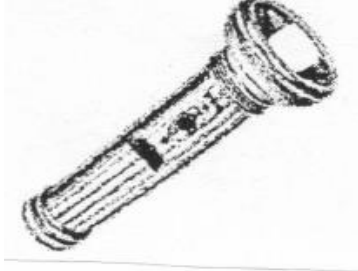
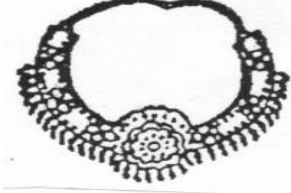
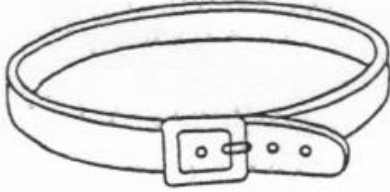
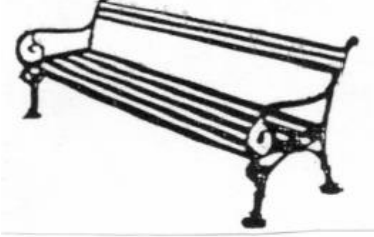
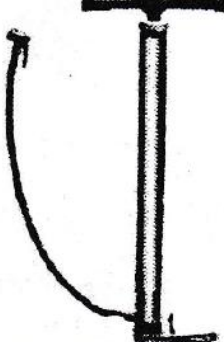
मुक्त प्रतीकों की सूची



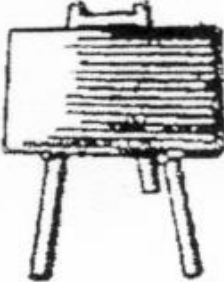

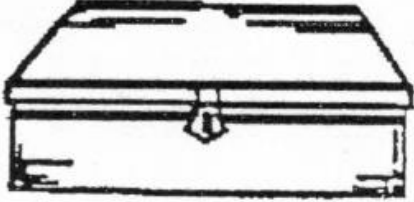

TABLE-IV



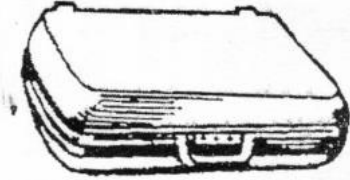


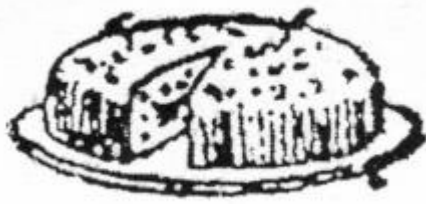
(LIST OF FREE SYMBOLS)

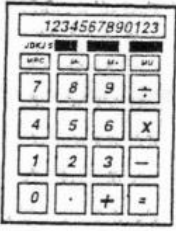
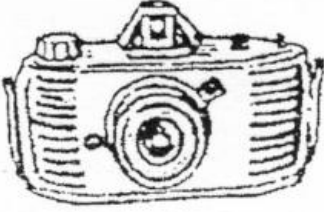
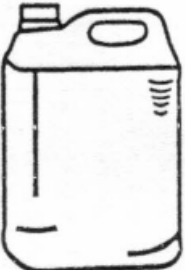

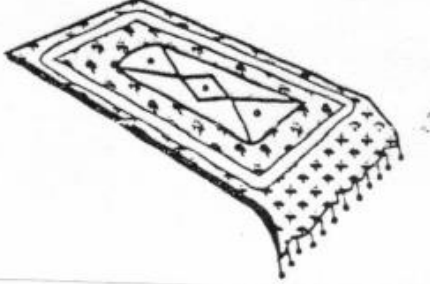
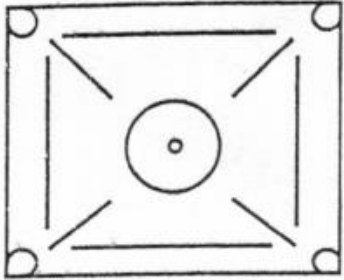
S.No	Symbol	Image	प्रतीक
1.	Air Conditioner		एअरकंडीस्नर
2.	Almirah		अलमारी
3.	Apple (In all States and Union Territories except in the States of Arunachal Pradesh, Assam, Manipur, Meghalaya, Mizoram, Nagaland, Sikkim, Tripura, Puducherry, Tamil Nadu, Kerala & Karnataka)		सेब (अरुणाचल प्रदेश, असम, मणिपुर, मेघालय, मिजोरम, नागालैंड, सिक्किम, त्रिपुरा, पुडुचेरी, तमिलनाडु, केरल एवं कर्नाटक राज्यों को छोड़कर सभी राज्यों और संघ राज्य क्षेत्रों में)

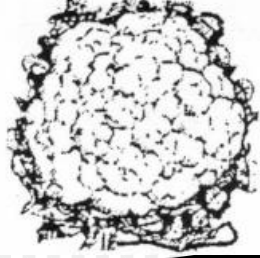

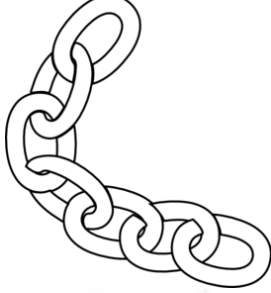
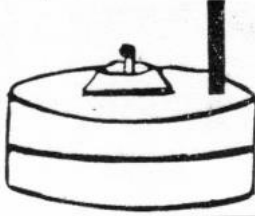


4.	Auto- Rickshaw <i>(In all States and Union Territories except in the States of Andhra Pradesh and Telangana)</i>		ऑटो-रिक्शा <i>(आंध्र प्रदेश एवं तेलंगाना राज्यों को छोड़कर सभी राज्यों और संघ राज्य क्षेत्रों में)</i>
5.	Baby Walker		बेबी वॉकर
6.	Balloon		गुब्बारा
7.	Bangles		चूड़ियाँ
8.	Basket containing Fruits <i>(In all States and Union Territories except in the State of Tamil Nadu)</i>		फलों से युक्त टोकरी <i>(तमिल नाडू राज्य को छोड़कर सभी राज्यों और संघ राज्य क्षेत्रों में)</i>
9.	Bat		बल्ला

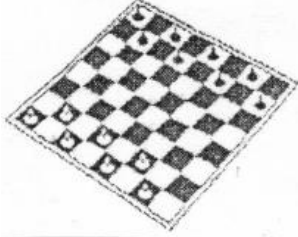



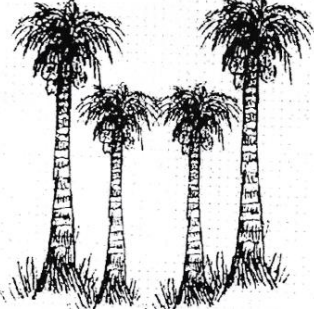
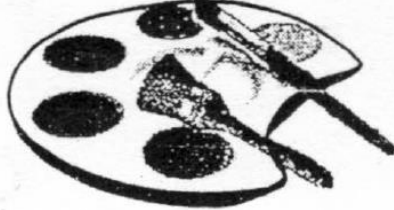
10.	Batsman		बल्लेबाज
11.	Battery Torch		बैटरी टार्च
12.	Bead Necklace		मोतियों का हार
13.	Belt		बेल्ट
14.	Bench		बेन्च
15.	Bicycle Pump		साइकिल पम्प

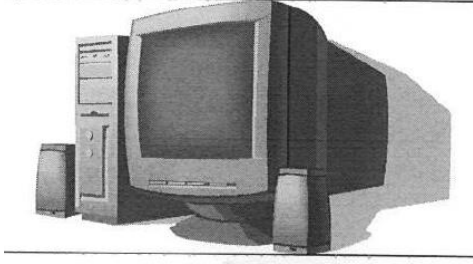

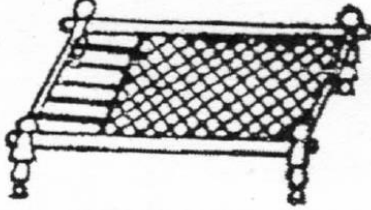
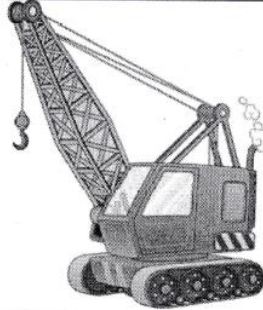
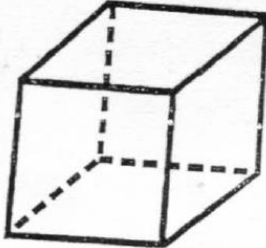
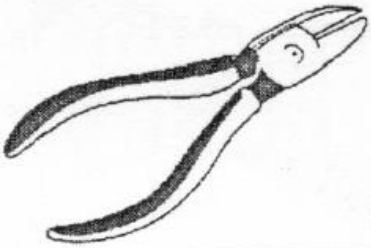
16.	Binoculars		दूरबीन
17.	Biscuit		बिस्कुट
18.	Black Board		ब्लैक बोर्ड
19.	Boat with Man and Sail		आदमी व पाल युक्त नौका
20.	Box		बक्सा
21.	Bread		डबल रोटी

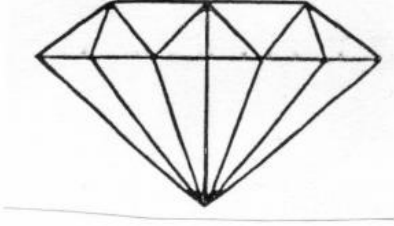
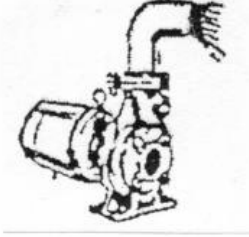

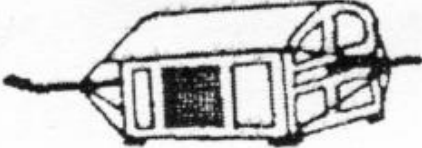

22.	Bread Toaster		ब्रेड टोस्टर
23.	Bricks		ईंटें
24.	Brief Case		ब्रीफकेस
25.	Brush		ब्रुश
26.	Bucket		बाल्टी
27.	Cake		केक


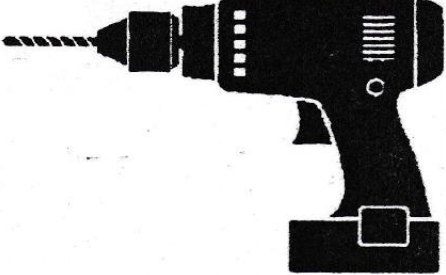
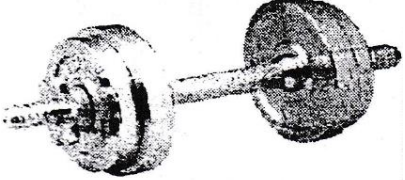


28.	Calculator		कैल्कूलेटर
29.	Camera		कैमरा
30.	Can		कैन
31.	Capsicum		शिमला मिर्च
32.	Carpet		कार्पेट
33.	Carrom Board		कैरम बोर्ड

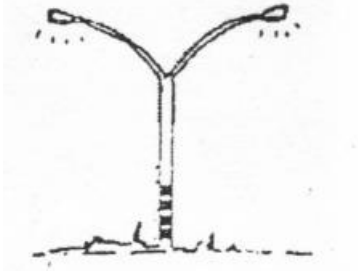
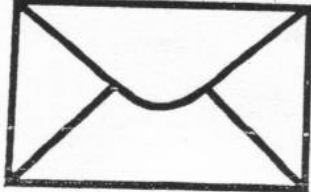
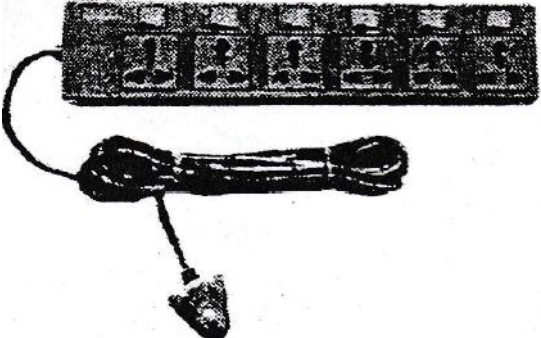
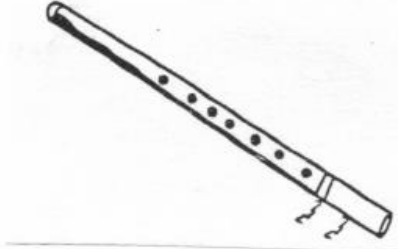

34.	Cauliflower		फूलगोभी
35.	CCTV Camera		सीसीटीवी कैमरा
36.	Chain		जंजीर
37.	Chakki		चक्की
38.	Chapati Roller		चपाती रोलर
39.	Chappals		चप्पलें




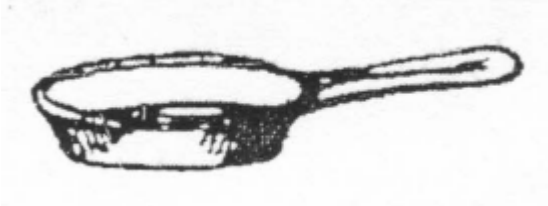
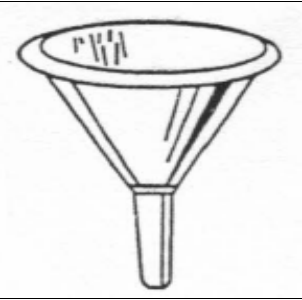

40.	Chess Board		शतरंज बोर्ड
41.	Chimney		चिमनी
42.	Clip		चिमटी
43.	Coat		कोट
44.	Coconut Farm		नारियल फार्म
45.	Colour Tray & Brush		कलर ट्रे और ब्रुश


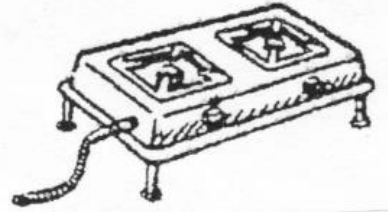




46.	Computer		कम्प्यूटर
47.	Computer Mouse		कम्प्यूटर माउस
48.	Cot <i>(In all States and Union Territories except in the State of Kerala)</i>		चारपाई (केरल राज्य को छोड़कर सभी राज्यों और संघ राज्य क्षेत्रों में)
49.	Crane		क्रेन
50.	Cube		घन
51.	Cutting Pliers		कटिंग प्लायर




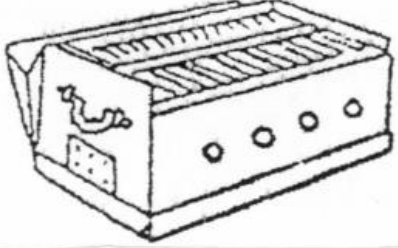


52.	Diamond		हीरा
53.	Diesel Pump		डीजल पम्प
54.	Dish Antenna		डिश एंटीना
55.	Dolli		डोली
56.	Door Bell		द्वार घंटी







57.	<p>Door Handle <i>(In all States and Union Territories except in the States of Uttar Pradesh and Uttarakhand)</i></p>		<p>दरवाजे का हैंडल (उत्तर प्रदेश एवं उत्तराखण्ड राज्य को छोड़कर सभी राज्यों और संघ राज्य क्षेत्रों में)</p>
58.	<p>Drill Machine</p>		<p>ड्रिल मशीन</p>
59.	<p>Dumbbells</p>		<p>डम्बल्स</p>
60.	<p>Dustbin</p>		<p>कूड़ादान</p>
61.	<p>Ear Rings <i>(In all States and Union Territories except in the States of Tamil Nadu, Puducherry, Kerala and Karnataka)</i></p>		<p>कान की बालियाँ (तमिलनाडू, पुडुचेरी, केरल एवं कर्नाटक राज्य को छोड़कर सभी राज्यों और संघ राज्य क्षेत्रों में)</p>


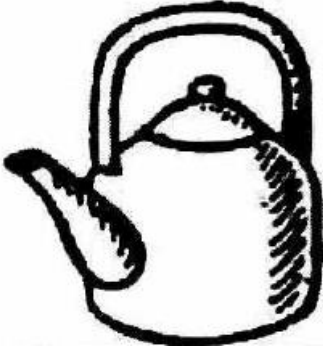


62.	Electric Pole		बिजली का खंभा
63.	Envelope		लिफाफा
64.	Extension Board		एक्सटेंशन बोर्ड
65.	Flute		बाँसुरी
66.	<p>Football <i>(In all States and Union Territories except in the States of Arunachal Pradesh, Assam, Manipur, Meghalaya, Mizoram, Nagaland, Sikkim and Tripura)</i></p>		<p>फुटबॉल <i>(अरुणाचल प्रदेश, असम, मणिपुर, मेघालय, मिजोरम, नागालैंड, सिक्किम, एवं त्रिपुरा राज्यों को छोड़कर सभी राज्यों और संघ राज्य क्षेत्रों में)</i></p>

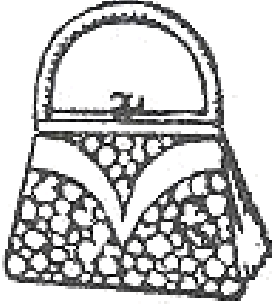

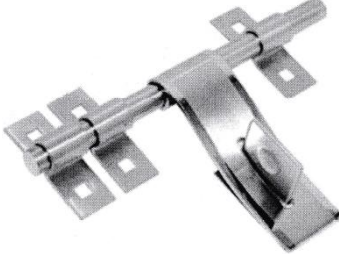

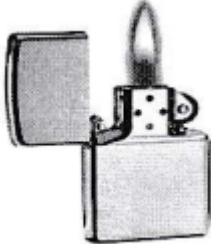
67.	Football Player		फुटबॉल खिलाड़ी
68.	Fountain		फव्वारा
69.	Frock		फ्राक
70.	Frying Pan		फ्राइंग पैन
71.	Funnel		कीप
72.	Ganna Kisan		गन्ना किसान

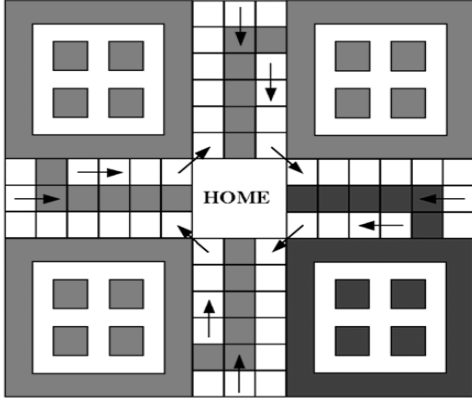
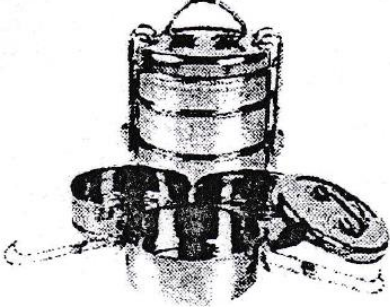
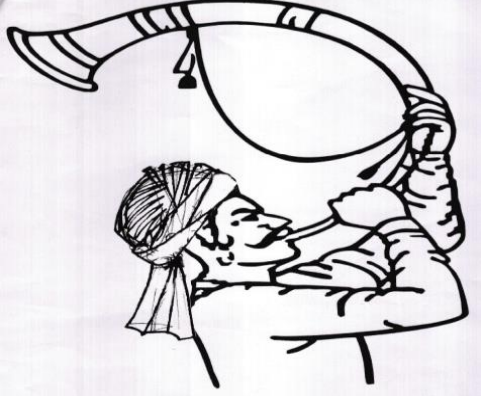


73.	Gas Cylinder		गैस सिलेण्डर
74.	Gas Stove		गैस का चूल्हा
75.	Gift Pack		उपहार
76.	Ginger		अदरक
77.	Glass Tumbler		काँच का गिलास
78.	Gramophone		ग्रामोफोन

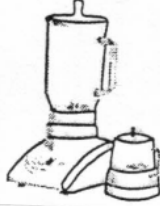

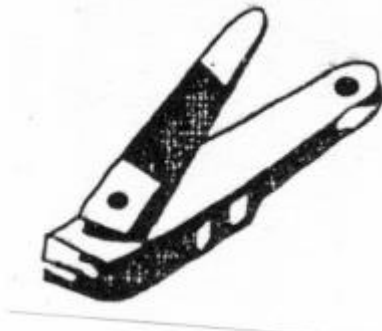

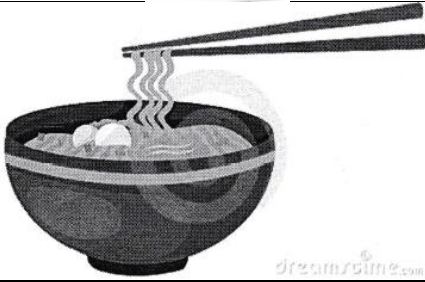

79.	Grapes		अंगूर
80.	Green Chilli		हरी मिर्च
81.	Hand Cart		हाथ गाड़ी
82.	Harmonium		हारमोनियम
83.	<p>Hat (In all States and Union Territories except in the States of Andhra Pradesh and Telangana)</p>		<p>टोप (आंध्र प्रदेश एवं तेलंगाना राज्य को छोड़कर सभी राज्यों और संघ राज्य क्षेत्रों में)</p>
84.	Head Phone		हेडफोन



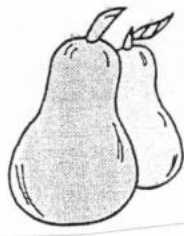
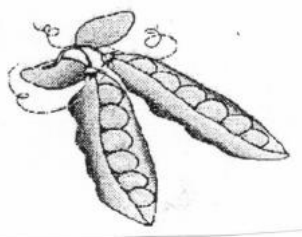


85.	Helmet		हेलमेट
86.	Hockey and Ball		हॉकी और बॉल
87.	Hour Glass		रेत घड़ी
88.	Ice Cream <i>(In all States and Union Territories except in the State of Tamil Nadu)</i>		आइस क्रीम <i>(तमिल नाडू राज्य को छोड़कर सभी राज्यों और संघ राज्य क्षेत्रों में)</i>
89.	Immersion Rod		पानी गरम करने की रॉड
90.	Iron <i>(In all States and Union Territories except in the States of Andhra Pradesh and Telangana)</i>		प्रेस <i>(आंध्र प्रदेश एवं तेलंगाना राज्यों को छोड़कर सभी)</i>

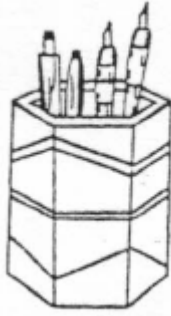
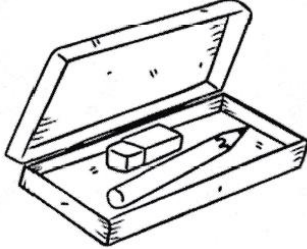
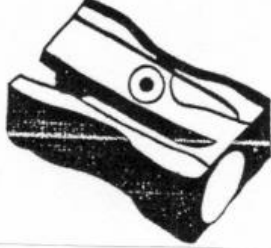
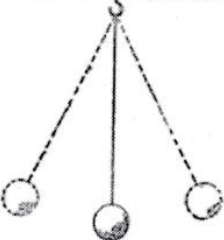


			राज्यों और संघ राज्य क्षेत्रों में)
91.	Jackfruit		कटहल
92.	Kettle (In all States and Union Territories except in the States of Arunachal Pradesh, Assam, Manipur, Meghalaya, Mizoram, Nagaland, Sikkim, Tripura and West Bengal)"		केतली (अरुणाचल प्रदेश, असम, मणिपुर, मेघालय, मिजोरम, नागालैंड, सिक्किम, त्रिपुरा एवं पश्चिम बंगाल राज्यों को छोड़कर सभी राज्यों और संघ राज्य क्षेत्रों में)
93.	Kitchen Sink		किचन सिंक
94.	Lady Finger		भिंडी


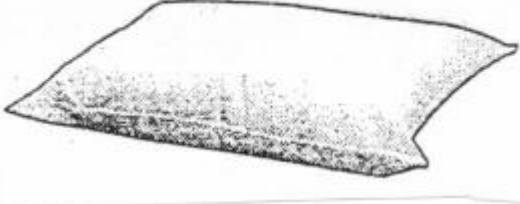

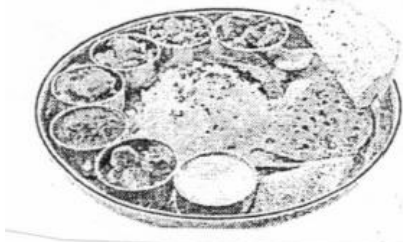
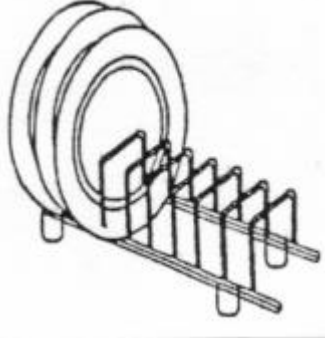

95.	<p>Lady Purse <i>(In all States and Union Territories except in the States of Arunachal Pradesh, Assam, Manipur, Meghalaya, Mizoram, Nagaland, Sikkim, Tripura and West Bengal)</i></p>		<p>लेडी पर्स <i>(अरुणाचल प्रदेश, असम, मणिपुर, मेघालय, मिजोरम, नागालैंड, सिक्किम, त्रिपुरा एवं पश्चिम बंगाल राज्यों को छोड़कर सभी राज्यों और संघ राज्य क्षेत्रों में)</i></p>
96.	<p>Laptop</p>		<p>लैपटॉप</p>
97.	<p>Latch</p>		<p>कुन्डी</p>
98.	<p>Letter Box</p>		<p>लैटर बाक्स</p>
99.	<p>Lighter</p>		<p>लाइटर</p>



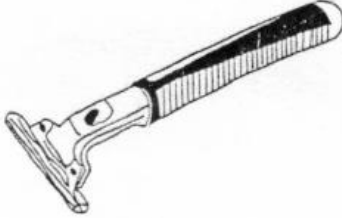
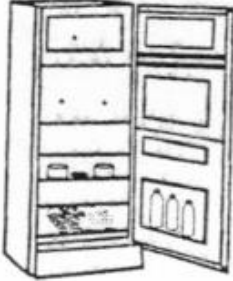

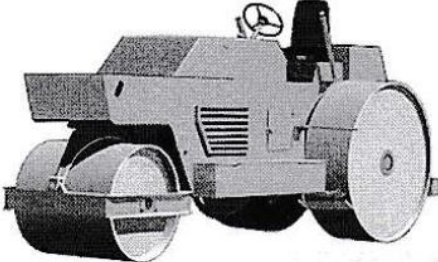
100	Ludo		लूडो
101	Lunch Box		लन्च बॉक्स
102	Man Blowing Turha		तुरहा बजाता आदमी
103	Matchbox		माचिस की डिब्बी
104	Mike		माईक

105	Mixee		मिक्सी
106	Nagrik		नागरिक
107	Nail Cutter		नेल कटर
108	Neck Tie		गले की टाई
109	Noodles Bowl		नूडल्स कटोरा
110	Pan		कड़ाही

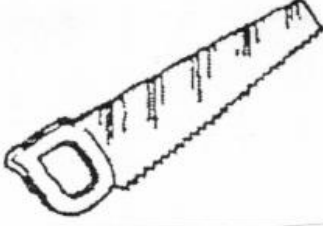

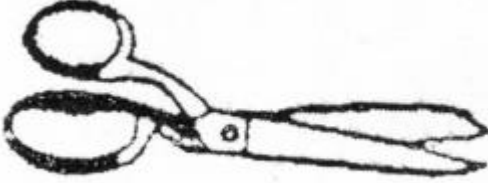
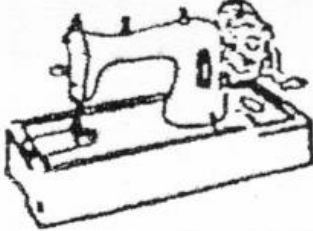

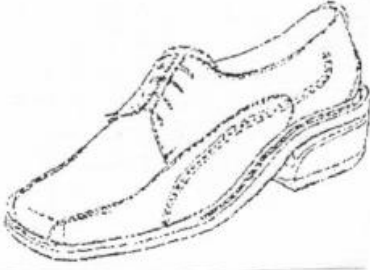
111	Pants		पैंट
112	Peanuts		मूँगफली
113	Pears <i>((In all States and Union Territories except in Tamil Nadu and Puducherry))</i>		नाशपाती <i>(तमिल नाडू एवं पुडुचेरी राज्य को छोड़कर सभी राज्यों और संघ राज्य क्षेत्रों में)</i>
114	Peas		मटर
115	Pen Drive		पेन ड्राइव
116	Pen Nib with Seven Rays		कलम की निब सात किरणों के साथ



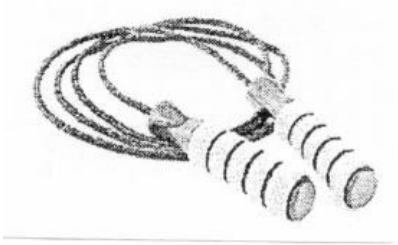
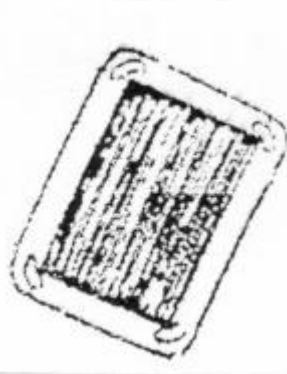

117	Pen Stand		पैन-स्टैण्ड
118	Pencil Box		पेन्सिल डिब्बा
119	Pencil Sharpener		पेन्सील शार्पनर
120	Pendulum		पेन्डुलम
121	Pestle and Mortar		मूसल और खरल
122	Petrol Pump		पेट्रोल पम्प






123	Phone Charger		फोन चार्जर
124	Pillow		तकिया
125	Plastering Trowel		करनी
126	Plate Containing Food		खाने से भरी थाली
127	Plate Stand		प्लेट स्टैण्ड
128	Pot		हान्डी



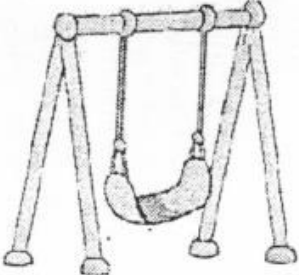
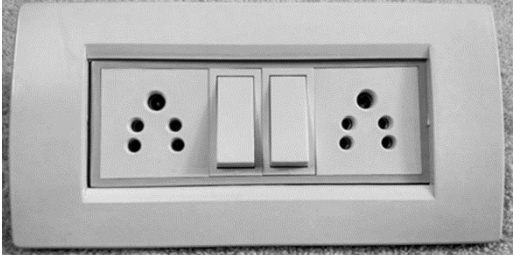

129	Pressure Cooker		प्रेशर कुकर
130	Punching Machine		पंचिंग मशीन
131	Razor		रेजर
132	Refrigerator		रेफ्रिजरेटर
133	Ring		अंगूठी
134	Road Roller		रोड रोलर


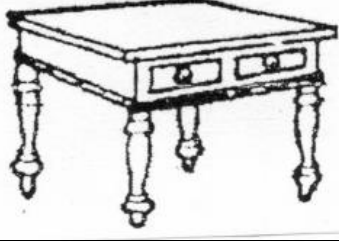
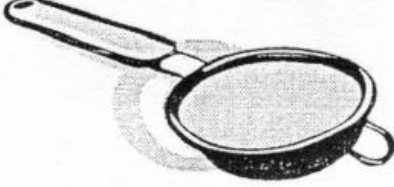

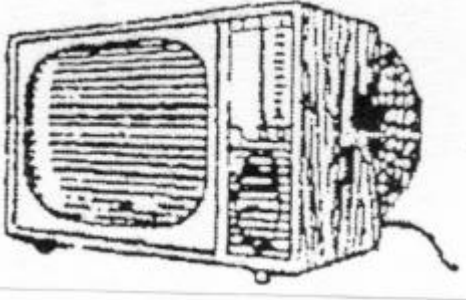
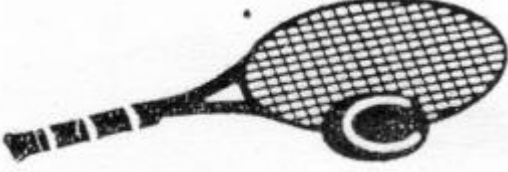
135	Robot		रोबोट
136	Room Cooler		रूम कूलर
137	Room Heater		रूम हीटर
138	Rubber Stamp		रबड़ की मुहर
139	Safety Pin		सेफ्टी पिन

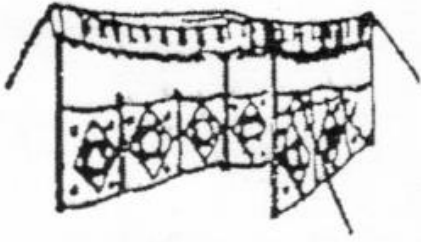

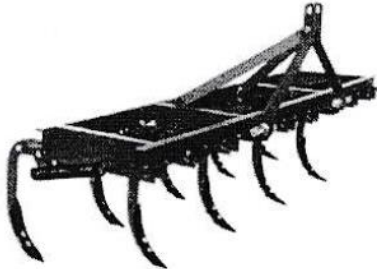
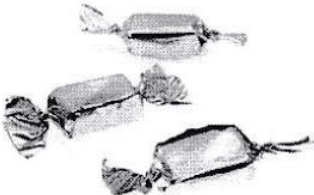
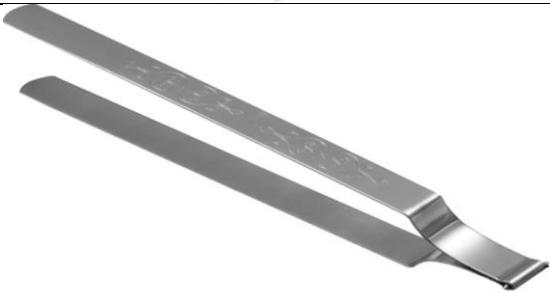
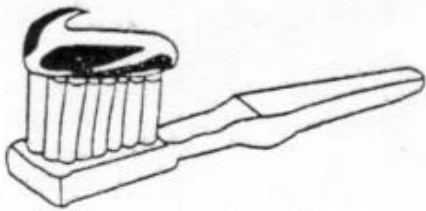
140	<p>Saw (In all States and Union Territories except in the State of Kerala)</p>		<p>आरी (केरल राज्य को छोड़कर सभी राज्यों और संघ राज्य क्षेत्रों में)</p>
141	School Bag		स्कूल का बस्ता
142	Scissors		कैंची
143	Sewing Machine		सिलाई की मशीन
144	Ship		पानी का जहाज
145	Shoe		जूता

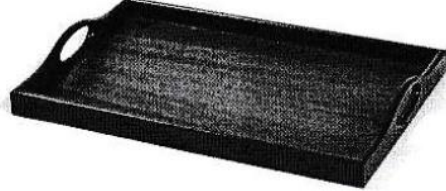
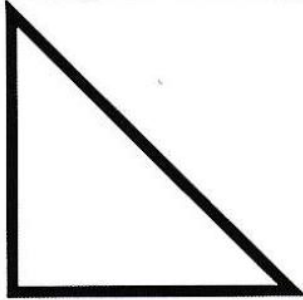

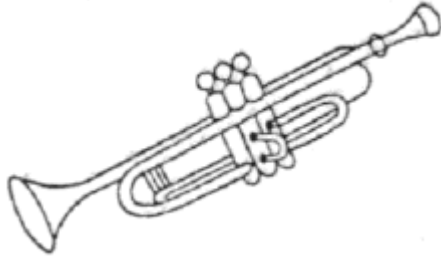

146	Shutter		शटर
147	Sitar		सितार
148	Skipping Rope		कूदने की रस्सी
149	Slate		स्लेट
150	Soap Dish		साबुनदानी

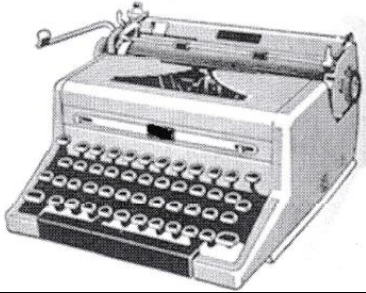



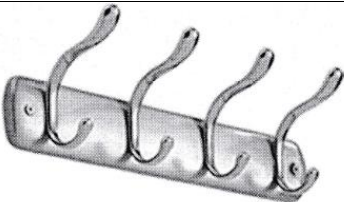
151	Socks		जुराबें
152	Sofa		सोफा
153	Spanner <i>(In all States and Union Territories except in the States of Bihar and Jharkhand)</i>		स्पैनर <i>(बिहार एवं झारखण्ड राज्यों को छोड़कर सभी राज्यों और संघ राज्य क्षेत्रों में)</i>
154	Stapler		स्टैपलर
155	Stethoscope		स्टैथोस्कोप



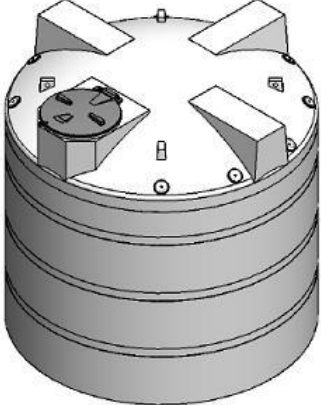

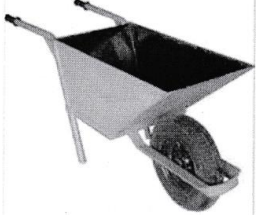
156	Stool		स्टूल
157	Stumps		स्पम्प्स
158	Swing		झूला
159	Switchboard		स्विच बोर्ड
160	Syringe		सिरिन्ज

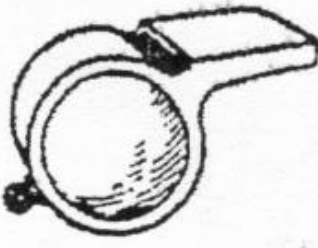
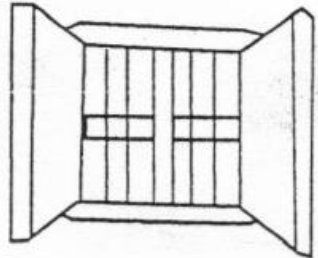
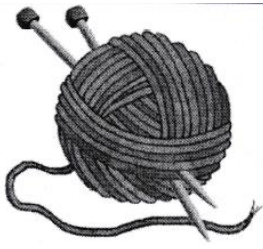
161	T.V. Remote		टी.वी. रिमोट
162	Table		मेज
163	Tea Filter		चाय छलनी
164	Telephone		टेलीफोन
165	Television		टेलीविजन
166	Tennis Racket & Ball		टेनिस बल्ला व गेंद

167	Tent		टैन्ट
168	Throwing a Javelin		भाला फेंक
169	Tiller		टीलर
170	Toffees		टॉफियाँ
171	Tongs <i>(In all States and Union Territories except in the States of Bihar and Jharkhand)</i>		चिमटा <i>(बिहार एवं झारखण्ड राज्यों को छोड़कर सभी राज्यों और संघ राज्य क्षेत्रों में)</i>
172	Tooth Brush		दाँत बुश

173	Tooth Paste		टूथपेस्ट
174	Tray		ट्रे
175	Triangle		त्रिभुज
176	Truck <i>(In all States and Union Territories except in the States of Andhra Pradesh and Telangana)</i>		ट्रक <i>(आंध्र प्रदेश एवं तेलंगाना राज्यों को छोड़कर सभी राज्यों और संघ राज्य क्षेत्रों में)</i>
177	Trumpet		तुरही
178	Tube light		ट्यूब लाईट

179	Typewriter		टाईपमशीन
180	Tyres		टायर
181	Vacuum Cleaner		वैक्यूम क्लीनर
182	Violin		वायलिन
183	Walking Stick		छड़ी
184	Wall Hook		दीवार खूंटी
185	Wallet		बटुआ

186	Walnut		अखरोट
187	Water Melon		तरबूज़
188	Water Tank		पानी का टैंक
189	Well		कुआँ
190	Wheel Barrow		हाथ रेहडी

191	Whistle		सीटी
192	Window		खिड़की
193	Wool and Needle		ऊन व सिलाई